

Rhythm

Rhythm is different combinations of sound

connected to a main beat.

Historical facts about nursery rhymes.

Nursery Rhyme: _____.

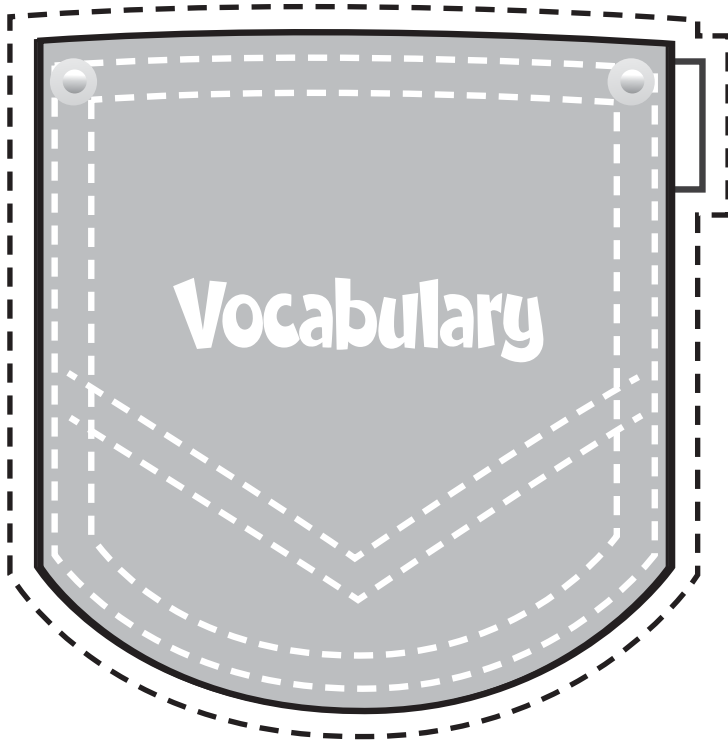

Main beat

The beat we carry in our heads to which we play music

Rhythm

Different patterns of sound connected to the main beat

Measure

How beats are organized

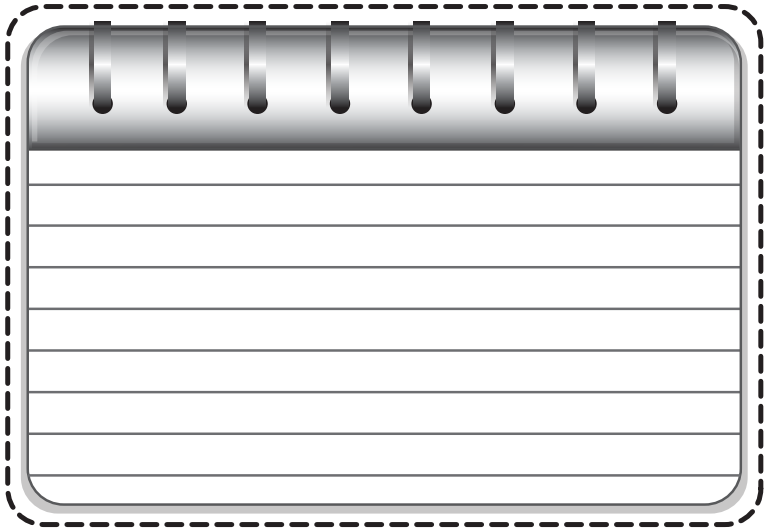
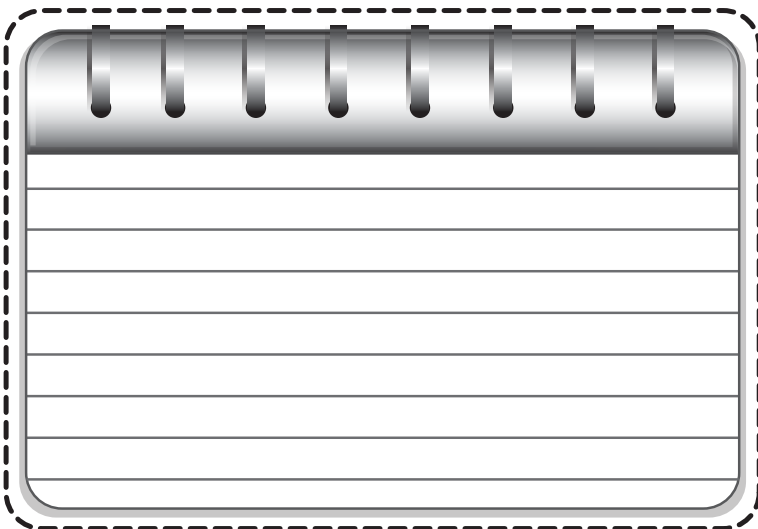

Strong Beats



Weak Beats

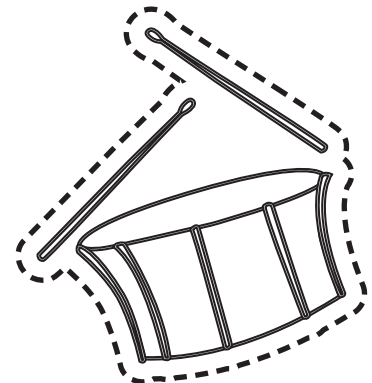
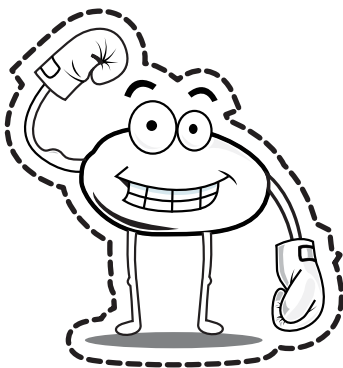
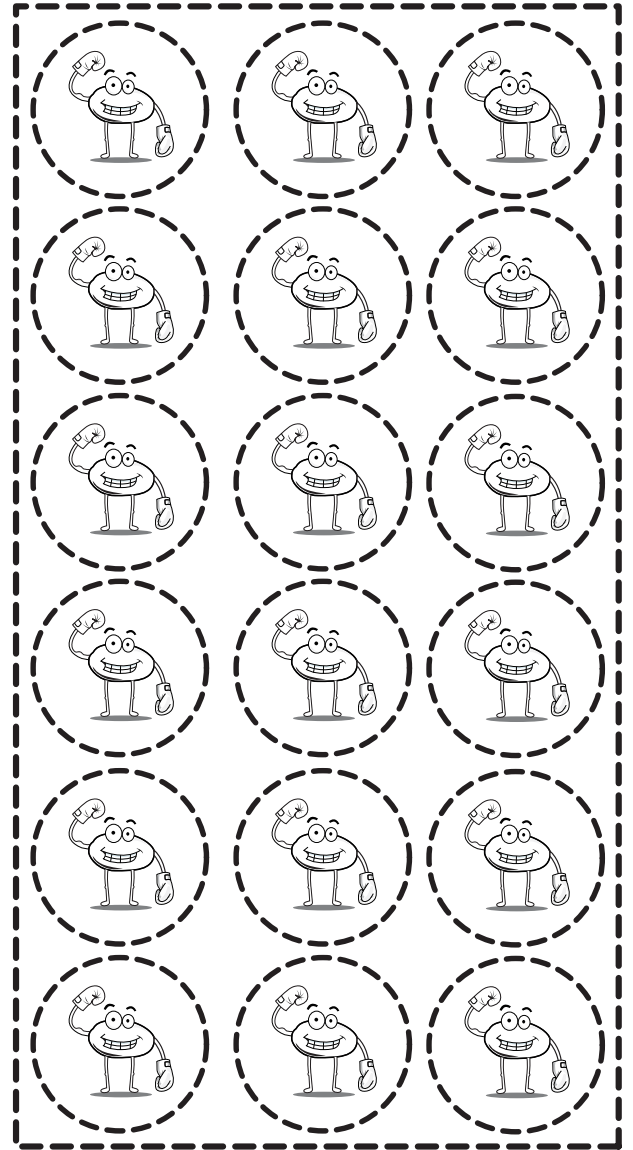

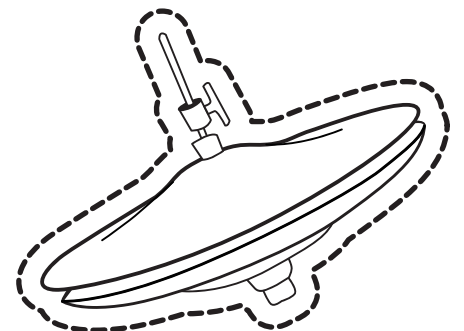
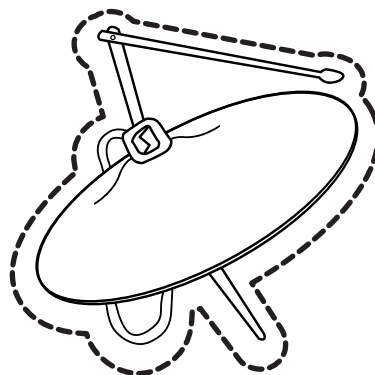
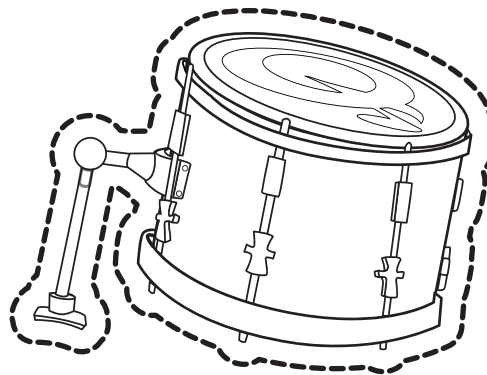
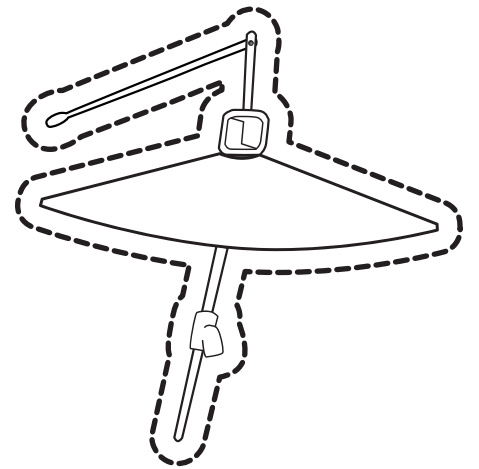
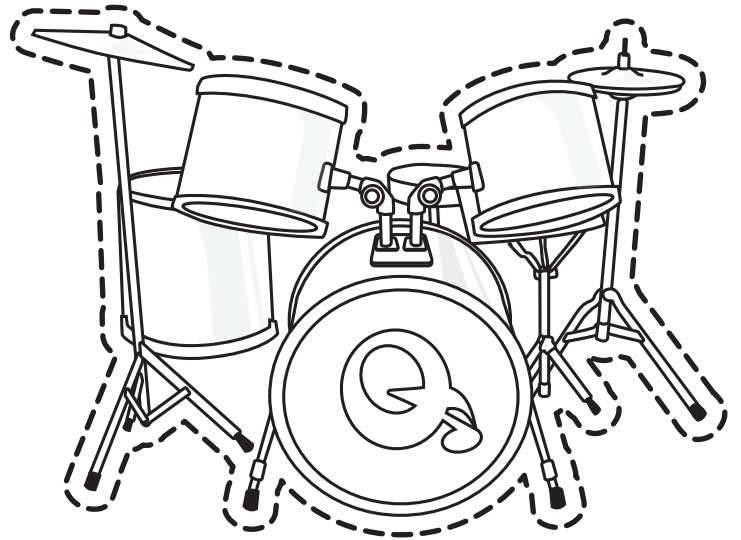

Beat boxes
