

Meter

Meter is how beats are organized in a measure.

Musical meters and dance steps are closely related

Vocabulary

**Meter**

How beats feel when  
organized into measures

**Meter of 2**

**One strong beat and one weak beat**

**Meter of 3**

**One strong beat and two weak beats**

**Meter of 4**

**One strong beat and three weak beats**

**Strong beat**

**The first beat in a measure**

**Weak beat**

**The beats in a measure following the strong beat**

**March**

**A dance in a meter of 2**

**Waltz**

**A dance in a meter of 3**

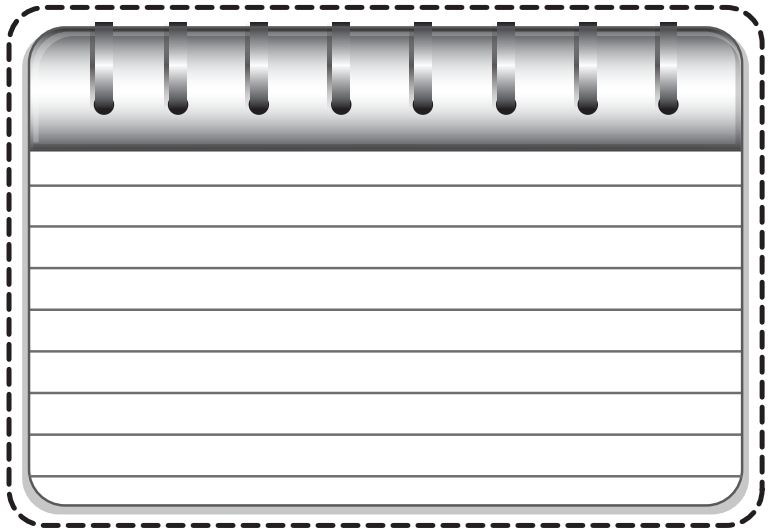
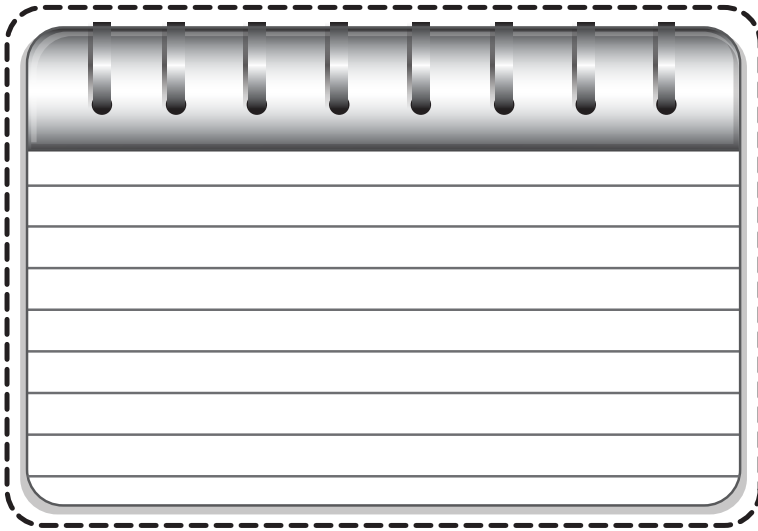

**Weak Beats**

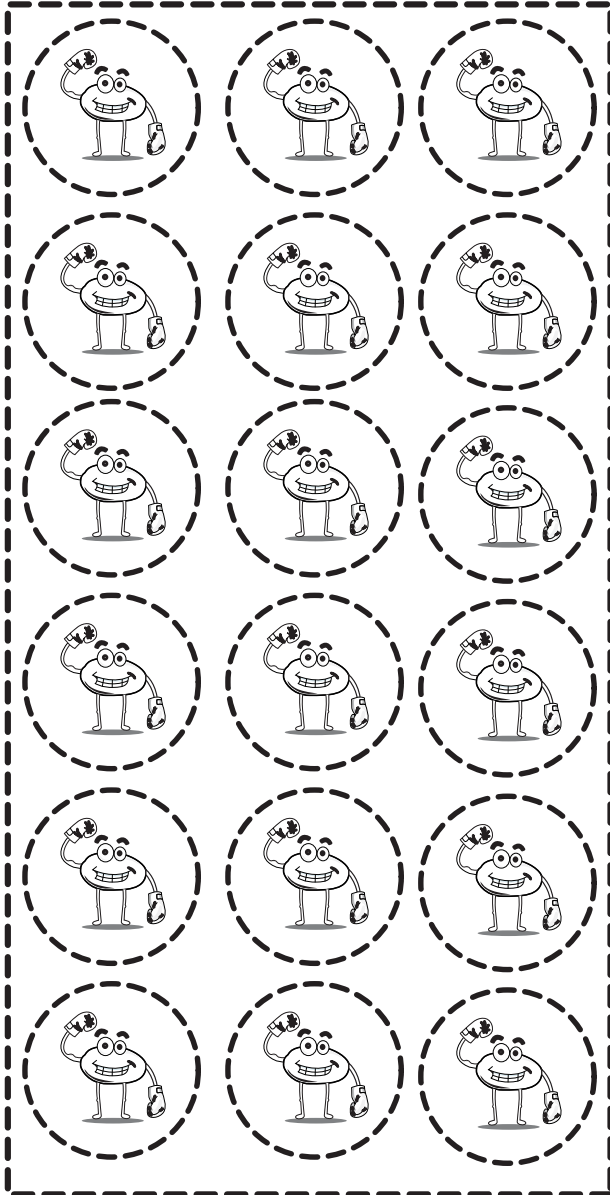

**Strong Beats**



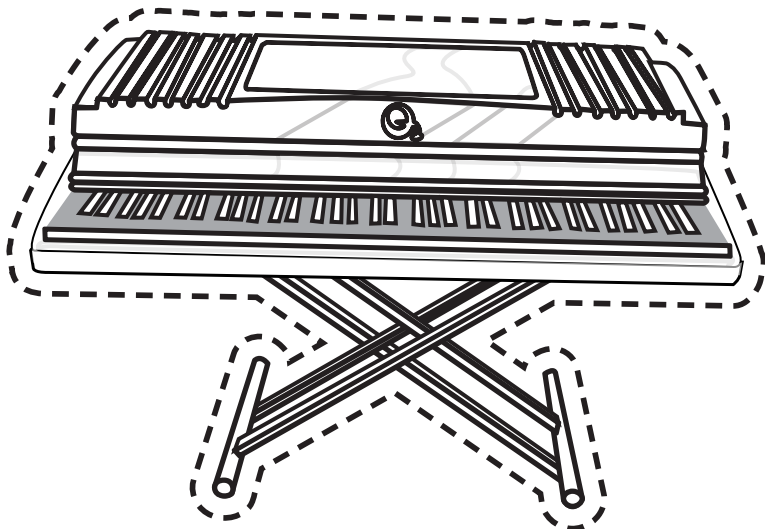
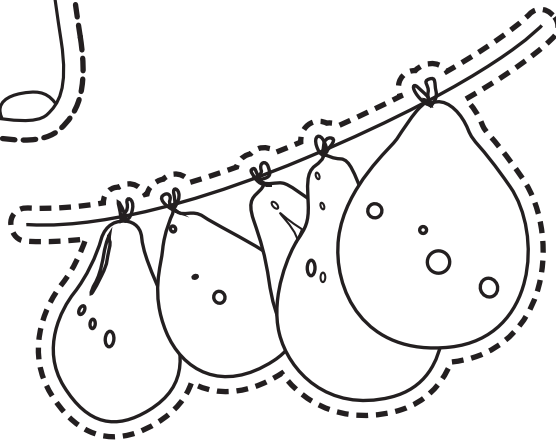
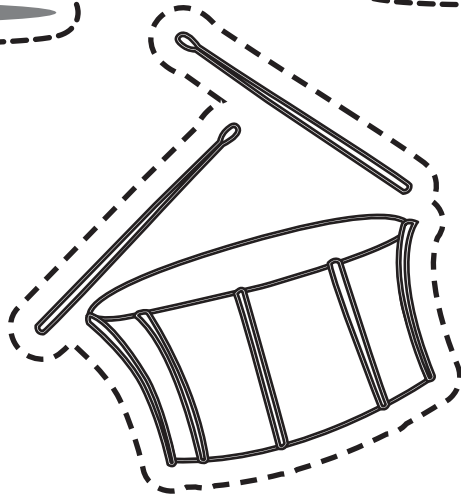
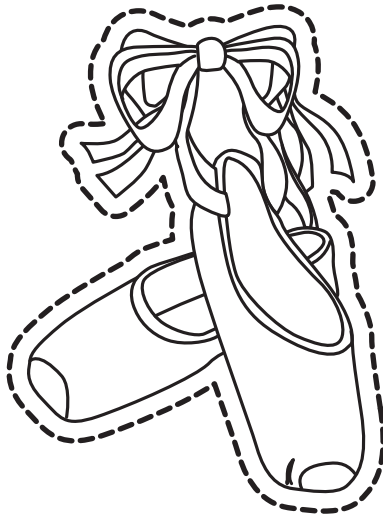
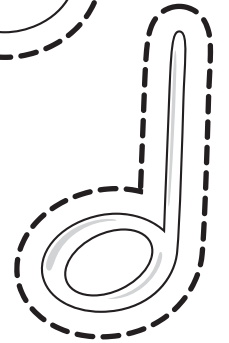
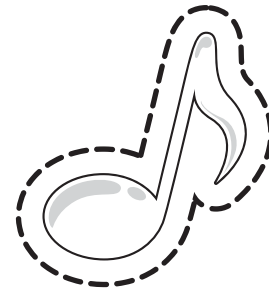
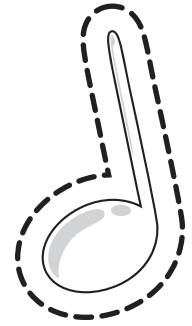
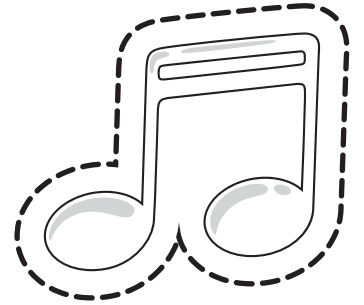
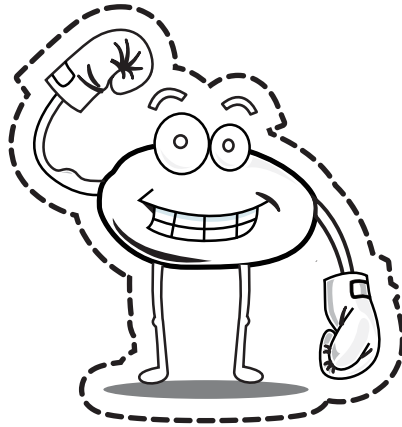

**Meter in** \_\_\_\_\_

**Meter in** \_\_\_\_\_

**Meter in** \_\_\_\_\_